



# Use and Maintenance Manual

## ATS BASIC CONTROL PANEL

Filename: Use and Maintenance  
Manual  
Rev. 01 Date: 01/03/2016  
Product: ATS BASIC Control Panel

## INDEX

<b>1</b>	<b>Introduction to the manual .....</b>	<b>3</b>
<b>2</b>	<b>General conditions of use .....</b>	<b>4</b>
<b>3</b>	<b>Installation Instructions .....</b>	<b>5</b>
	3.1 Safety distances .....	6
	3.2 Control Panel protection .....	6
<b>4</b>	<b>Start-up.....</b>	<b>7</b>
	4.1 Voltage change.....	7
	4.2 Operating logic (standard version).....	8
	4.2.1 Switch carried out by interlocked contactors.....	9
	4.2.2 Switch carried out by motorized changeover switch .....	9
	4.2.3 Interconnection among power cables and tightening torque .....	13
	4.2.4 AUTO Operating mode .....	14
	4.2.5 GENSET Operating mode .....	16
	4.2.6 MAINS Operating mode.....	16
	4.2.7 0 Operating mode .....	16
<b>5</b>	<b>Composition of the Panel .....</b>	<b>17</b>
	5.1 Connection interface terminal board (Switch and Auxiliaries).....	20
<b>6</b>	<b>Check and maintenance .....</b>	<b>23</b>
<b>7</b>	<b>Transport, storage and decommissioning .....</b>	<b>24</b>
<b>8</b>	<b>Faults and possible causes .....</b>	<b>25</b>
<b>9</b>	<b>How to ask for assistance .....</b>	<b>26</b>
<b>10</b>	<b>Our range: overall dimensions .....</b>	<b>27</b>

# 1 Introduction to the manual

SICES is pleased to thank you for purchasing our ATS BASIC Automatic Transfer Switch Panel. This Control Panel is the result of the design, the selection of the best components, the careful assembly and the strict test to which all SICES products are submitted.

We would like to recommend to read this manual carefully, to observe the safety rules and all regulations for the correct use and maintenance of the ATS BASIC Control Panel. This will guarantee you better duration results and efficiency.



For any doubts or questions, please do not hesitate to contact our technicians for clarifications.

The information contained in this manual are updated to the printing stage, but they may still be modified without notice in compliance with our aims of continuous development and improving of products.

This manual and all the enclosed documents are to be intended as part of the Control Panel and are intended to be read by all persons are involved in the life cycle of the machinery. Therefore they must be collected in a well-known place and be accessible to the operators, keeping them carefully in order to avoid their loss and/or deterioration.

This manual has been drafted for the installer, the user and the maintenance technician. It is compulsory to read it carefully and examine all electrical diagrams and instructions enclosed, as they provide indications on the Control Panel use and they also show the technical characteristics as well as the installation and assembling features.

## **The Customer must complies with all the safety instructions.**

	<p><b>WARNING:</b> The automatic transfer switch control panel must be only used by properly trained personnel.</p>
	<p>The installation must only be planned and carried out by skilled personnel. Any fault in installation and use may cause serious damage to the machinery, to the user system and to the persons involved.</p>
	<p>We remind it is compulsory to respect the regulations in force in the country of installation; In case there would be different regulations in force on the same issue, the strictest ones must be respected.</p>

## 2 General conditions of use

The product has been designed and built in compliance with the safety rules in force, for uses normal environments. In order to avoid damages to things and persons, we recommend to use all the necessary precautions and to respect the state of the art.

The control panel sizes for the calculation of the dissipated thermal power have been estimated considering that no other heating sources occur nearby. If the control panel is placed into a room together with other panels, a suitable distance must be guaranteed in order to allow the dissipation of the heating produced.

The calculation has been carried out for a use at an **average environmental temperature of 35°C**, according to the rules CEI EN 60439-1 and IEC 439-1.



In case of need of use at a different environmental temperature, please contact our technical department for the proper evaluations.

The Control Panel is intended to be used only to the purpose for which it has been designed. Any other use is considered improper and therefore dangerous. 3.

### 3 Installation Instructions

	<p>Do not carry out or try to perform the start-up, maintenance, reparation or modification you have neither the competence nor the particular instructions. If any doubt persists after reading the following paragraphs and attachments, please do not hesitate to contact the SICES Technical Service. All operations must be always performed in compliance with the safety regulations.</p>
---	--

We recommend to check that the Control Panel is intact after unpacking. In case of any doubts, do not use it, but refer to the manufacturer under penalty of nullity of the warranty.

Before proceeding to the installation, ensure you checked and observed the following indications:

- All installation operations must be performed by skilled personnel who strictly observe the safety regulations in force in the country where the installation takes place;
- Ensure that the data on the label identifying the control panel comply with the plant values; in detail, check power, voltage, current and frequency;
- For the electric connection strictly follow the enclosed electric diagram (**it contains useful information**);
- In the connection of power and command lines we recommend you to guarantee at least the section value suggested;
- Ensure that the connection of the earthing protection conductor is always connected compatibly with the distribution system and the regulations in force in the country of use;
- **Ensure that the conductors of the auxiliary circuit are correctly connected. Also check the correct connection of phase and neutral conductors.**

	<p><b>A wrong or missed neutral conductor connection may cause serious damages to the Control Panel and to the distribution plants connected to it.</b></p>
---	---

Install the Control Panel according to the protection degree. We recommend you to use a cable gland with the same characteristics in order to avoid a decreasing of the protection value.

The Control Panels must be installed properly. Any faults, modifications to the original project or interference caused by external agents such as plants, animals, dust, mould, etc. must be removed or refreshed to the default values.

### 3.1 Safety distances

	<p>The panel must be placed at a safe distance from heating sources, fuel storage, flammable material (paper, cloth, etc.) and chemical substances: the precautions used must be the ones expected by the authorities in charge. The precautions used must be those approved by the competent authorities. In order to avoid potentially dangerous situations, isolate the area around the panel preventing unauthorised personnel from approaching.</p> <p>Although SICES products comply with the electromagnetic compatibility rules, still we strongly recommend <b>NOT</b> to install the Panel (and the Genset) next to equipment ejecting emissions.</p>
---	---

Pay special attention while assembling the Control Panel in order to prevent external elements from falling into the Panel, such as metal shavings or other which could damage or impede the operation of the electric components.

We remind the the CEI EN 60439-1 regulation assigns some INDIVIDUAL TESTS to the installer. In particular, please note the following points:

- 8.3.1. Device check that includes the wiring check and the insulation test;
- 8.3.3. Protection measurements control.

<p><b>Note</b></p>	<p>It is the installer's responsibility to provide a DECLARATION OF CONFORMITY on the Control Panel installation once the work has been completed.</p>
--------------------	--

	<p><b>WARNING: A wrong installation or electrical connection may cause serious damage to people, Genset, ATS LOGICA Panel and/or plant connected to it.</b></p>
---	---

### 3.2 Control Panel protection

In order to protect the panel from indirect contacts, overload and short-circuit, it is the installer's responsibility to connect a protection device on the MAINS and GENSET line with the correct characteristics and values for the installation point. In order to guarantee against electrodynamic stress caused by a short circuit for control panels fixed to the floor, it is necessary to fix the lines to each other or to a support. It is also necessary to provide supports for the power cables so that these do not weigh down the transfer switch connection bars.



It is the installer's responsibility to check that the electrical loads connected to the load and the related current values do not exceed the panel projected value.

	<p>The installer must provide the installation of all the necessary equipment aimed at guarantee a safe and correct operation of the system in which the ATS BASIC Control Panel and Genset are installed (e.g. coordination of the protections against direct and indirect contacts).</p>
---	--

**NOTE:** We recommend you to use the suitable equipment (overvoltage protectors) in order to protect the circuits directly supplied by the Mains from overvoltage due to atmospheric discharges or particular events.

## 4 Start-up

### 4.1 Voltage change

	<p><b>WARNING:</b> Every control panel is produced and configured for operations at: 400Vac – 50/60 Hz.</p>
	<p><b>WARNING:</b> all the change operations must be carried out before every start-up and with no voltage.</p>

The Control Panels are suitable for operating at different AC voltages: 220Vac.

- 1) 220V – 50/60Hz (only 160÷4000A)
- 2) 230V – 50/60Hz (only 160÷4000A)
- 3) 380V – 50/60Hz (only 160÷4000A)
- 4) 400V – 50/60Hz
- 5) 440V – 50/60Hz (only 160÷4000A).

In order to suit the structure to the new voltage level, it is necessary to carry out some simple electrical modifications inside the panel.

**VOLTAGE: 220V – 50/60Hz (only 160÷4000A)**

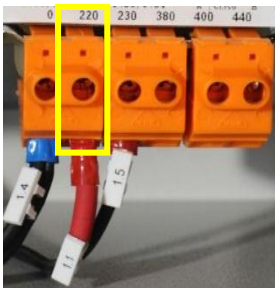

Move the cable 1.1 (identified by 3 red rings) to the terminal 220 of TR1.

**VOLTAGE: 230V – 50/60Hz (only 160÷4000A)**

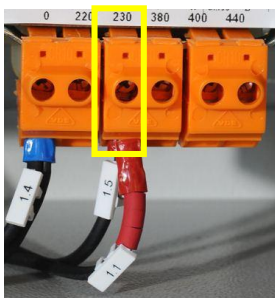

Move the cable 1.1 (identified by 3 red rings) to the terminal 230 of TR1 (together with the cable 230).

**VOLTAGE: 380V – 50/60Hz (only 160÷4000A)**

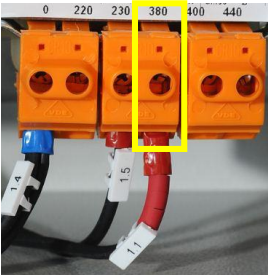

Move the cable 1.1 (identified by 3 red rings) to the terminal 380 of TR1.

**VOLTAGE: 400V – 50/60Hz (only 160÷4000A)**

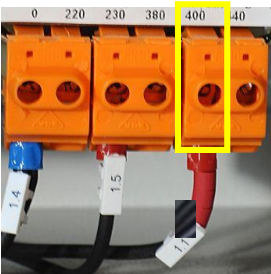

Move the cable 1.1 (identified by 3 red rings) to the terminal 400 of TR1.

**VOLTAGE: 440V – 50/60Hz (only 160÷4000A)**

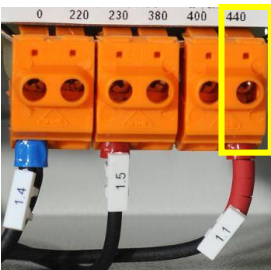

Move the cable 1.1 (identified by 3 red rings) to the terminal 440 of TR1.

## 4.2 Operating logic (standard version)



The ATS BASIC control panel is an equipment that allows to supply alternatively a plant supplied by two separate and autonomous sources of energy, which usually are: Mains and Genset.

According to the nominal current, besides the command circuits, inside the panel the switch is carried out by:

- 1) 2 4-pole mechanically and electrically interlocked contactors (45 ÷ 125A);
- 2) 1 4-pole motorized changeover switch (160 ÷ 4000A).

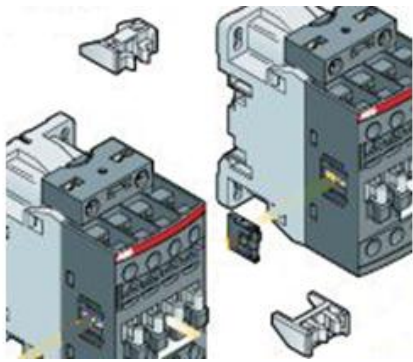

#### 4.2.1 Switch carried out by interlocked contactors.

Mechanical interlock		Auxiliary contacts
		
<b>45÷125A</b>		<b>45÷125A</b>

The contactors are interlocked by means of a proper accessory. In order to guarantee more safety to the system, besides the mechanical interlock, there is an electrical interlock carried out by auxiliary contacts installed on the front of each contactor.



With this configuration, only one of the two contactors can be commanded; the second one stays deactivated. In this way, the load is always supplied by only one source.

When the contactor is closed, the mechanical part in the figure stays blocked.

#### 4.2.2 Switch carried out by motorized changeover switch

The standard version considers the use of the following materials:

From 160A to 2500: Motorized changeover switch ABB SACE

From 3150 to 4000A: Motorized changeover switch TECHNOELECTRIC

On the front of the motorized changeover switch (160÷4000A) there is a mechanical indicator that shows the status of the main contacts. Therefore, it is possible to understand on which source the load is inserted. The figure below shows the possible statuses:

**ABB SACE**

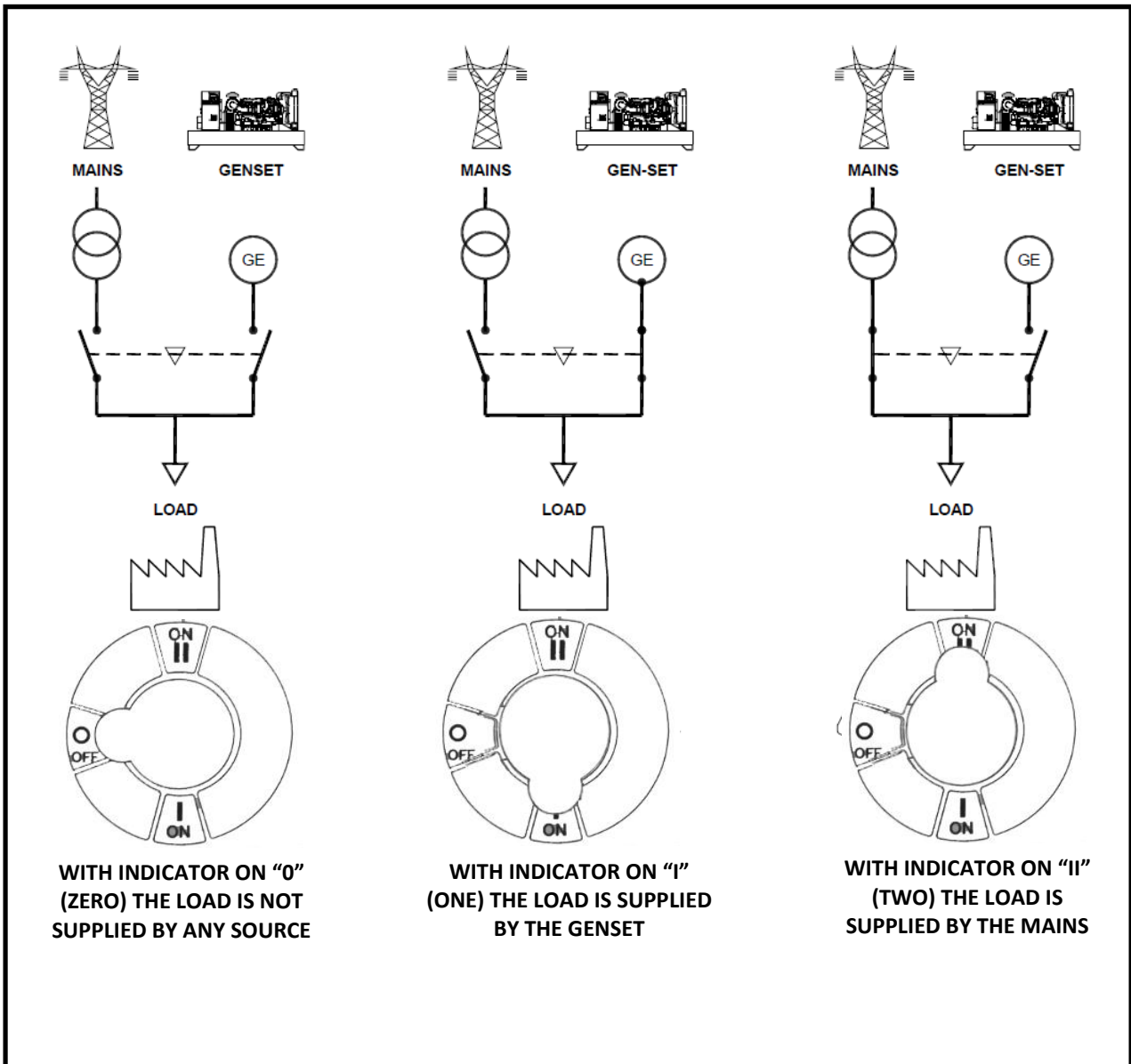

## TECHNOELECTRIC

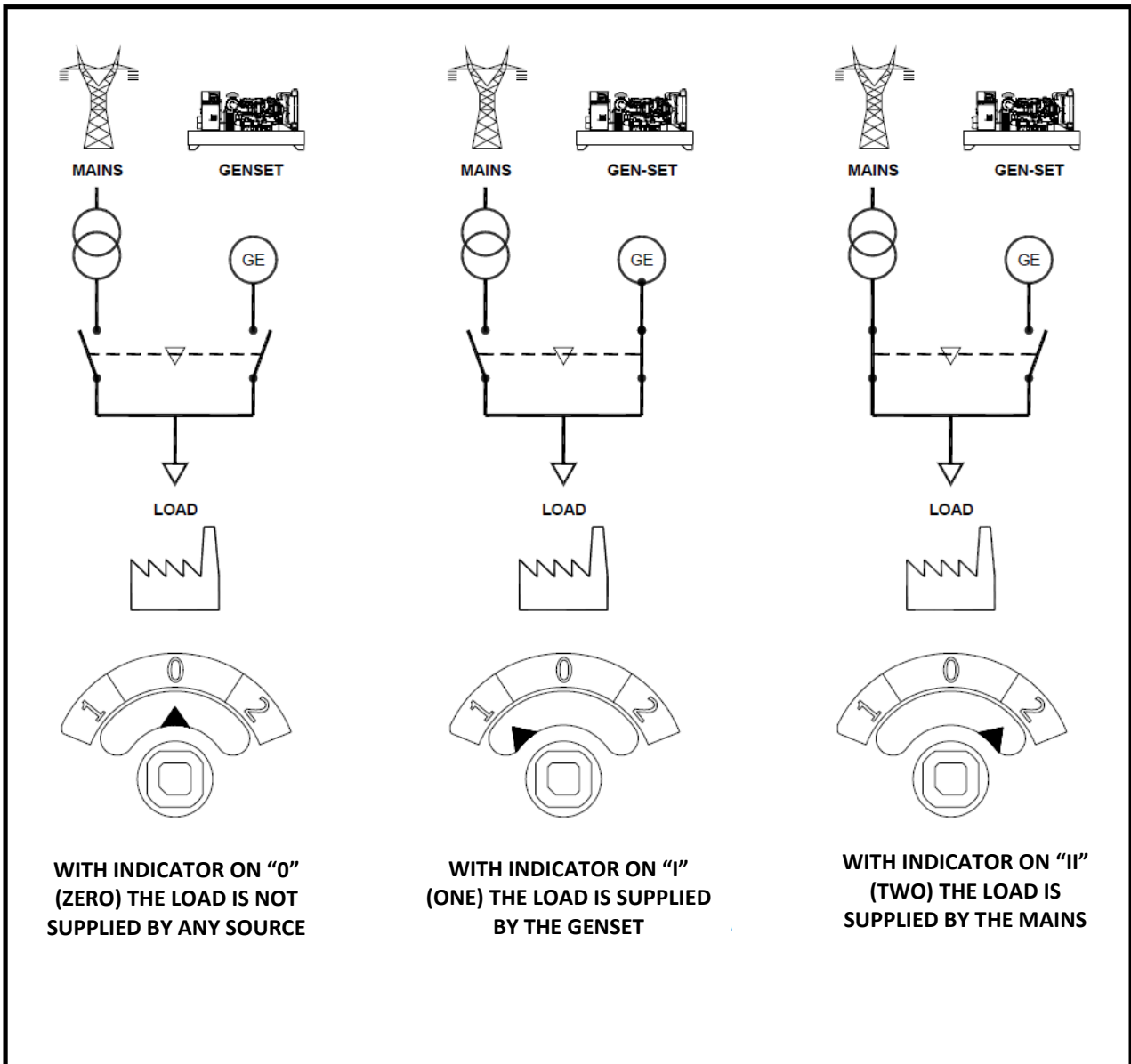

WITH INDICATOR ON "0"  
(ZERO) THE LOAD IS NOT  
SUPPLIED BY ANY SOURCE

WITH INDICATOR ON "I"  
(ONE) THE LOAD IS SUPPLIED  
BY THE GENSET

WITH INDICATOR ON "II"  
(TWO) THE LOAD IS  
SUPPLIED BY THE MAINS



**WARNING:** Check the cyclic sense of the MAINS and GENSET phases before supplying the LOAD.  
The inverse cyclic sense can cause serious damages to the system.

On the front of the switch there is a series of accessories:

- 1 **A lock that impedes any manual or electrical operation.**
- 2 **Mechanical indicator of the circuit breakers status.**
- 3 **Command selector switch: manual/automatic.**

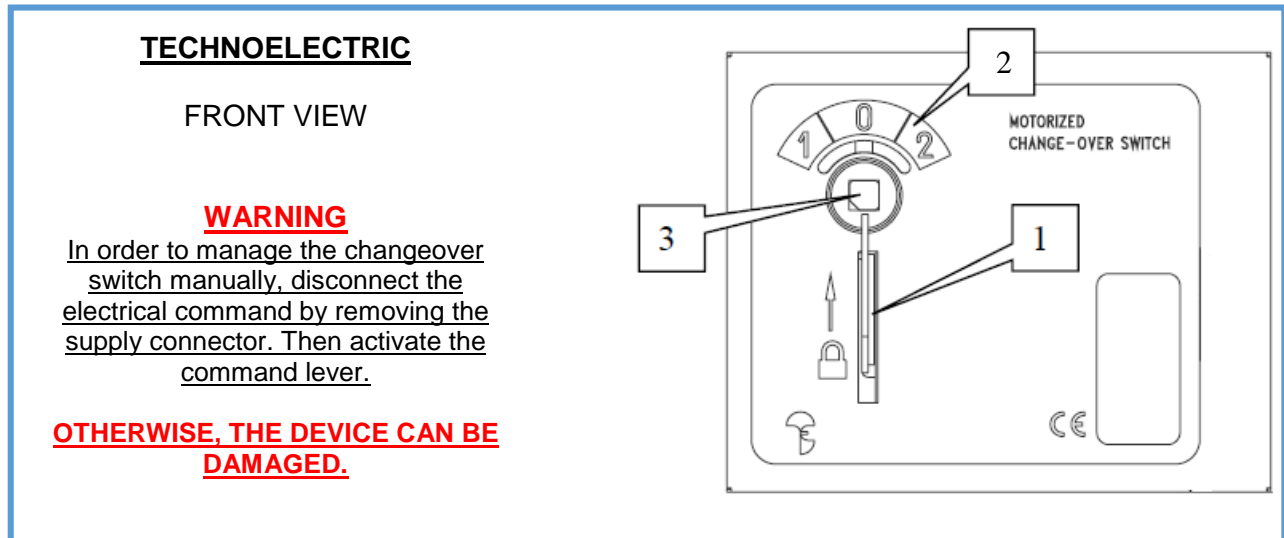
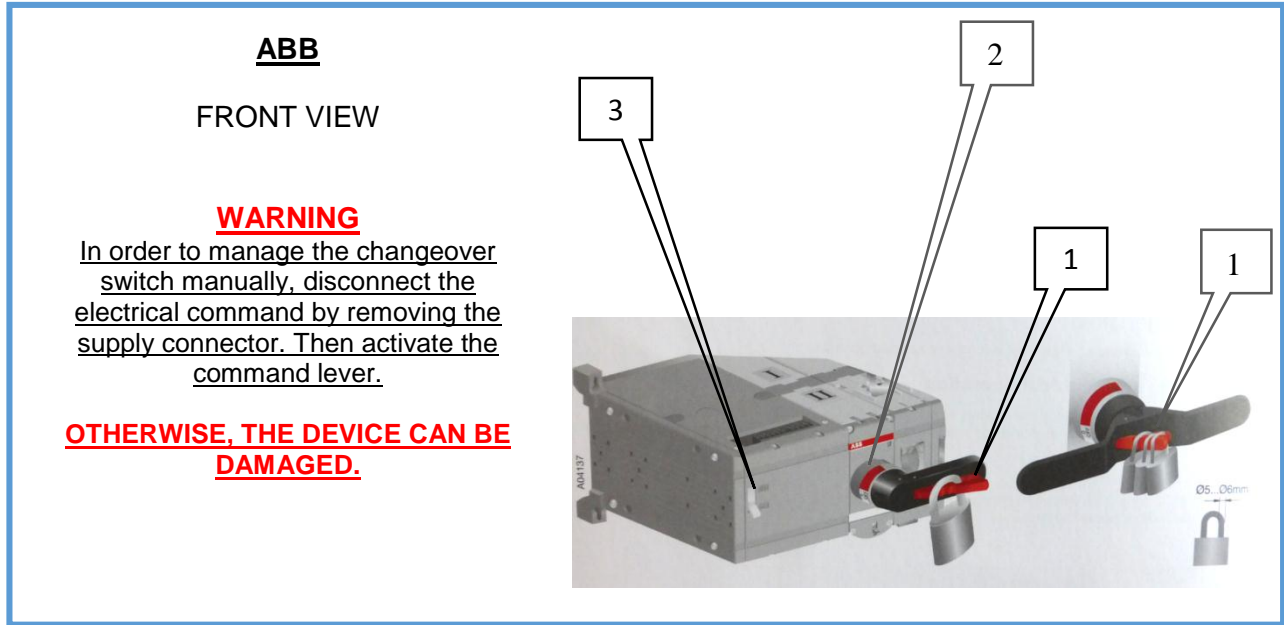

The locking device is important in case you would like to impede any operation by unauthorized persons, or to guarantee that nobody modifies the supply status creating damage to the people working in the plant. By means of the locking system placed on the front, you impede the activation of the manual command. With lock inserted the supply is stopped, inhibiting the electrical command.

The changeover switch, thanks to its exclusive mechanical structure, can be activated manually by a proper lever. This operation can be useful in case of device failure or in case of connection failure to the remote control logic.

In order to let the changeover switch be commanded automatically, the ATS BASIC panel must be connected to the MAINS-GENSET commands coming from the genset control panel. The SG selector switch on the panel must be positioned, in this case, on AUTOMATIC.

### 4.2.3 Interconnection among power cables and tightening torque

When the connection of the power cables MAINS-GENSET is carried out directly on the contactors terminals (sizes 45÷125A), the operation brings to the disconnection of the auxiliary circuits cables connected to the terminals. Pay attention during the reconnection of the auxiliary circuits cables to the power cables in the terminals. Before supplying, ensure that they have been reconnected correctly according to the diagram.

A wrong connection can cause damage to the auxiliary circuits inside the electrical control panel.



For the other sizes (160-4000A), this procedure is not necessary as the power cables connection is carried out on the extension bars.

Pay attention during the closure of the screws that keep the connectors in the terminal boards, avoid over pressing, respect the values below.

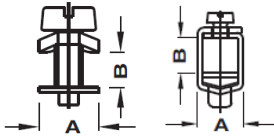
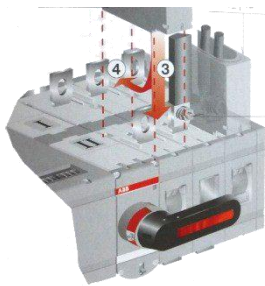
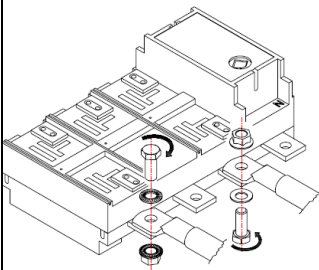
								
<b>TIGHTENING (MÁX.)</b>								
TERMINAL (40-125A)			MOTORIZED CHANGEOVER SWITCH (160-2500A)					MOTORIZED CHANGEOVER SWITCH (3150-4000A)
AF26	AF40 AF52	AF80	OTM160 OTM250	OTM400	OTM600 OTM800	OTM1000 OTM1600	OTM2000 OTM2500	CS6
M4 M5	M6	M8	M8	M10	M12	M12	M12	M14
2.5Nm	4Nm	6 Nm	22 Nm	44 Nm	75 Nm	75 Nm	75 Nm	70 Nm



**WARNING:** Before connecting phase and neutral cables of MAINS, GENSET and LOAD to the ATS BASIC panel, the installer is responsible for checking the type of electrical system of the plant.  
Pay attention while checking the neutral function. Remember **NOT TO SECTION IT** if the neutral and protection function has been selected (PEN).



**WARNING:** A wrong or failed connection of the neutral conductor may cause serious damages to the panel and to the related distribution systems.

#### 4.2.4 AUTO Operating mode



**Introduction:** with SG selector switch on AUTOMATIC, the switch is managed by external contacts (normally coming from the genset control panel), which are connected to the terminals X1-1, X1-2, X1-3 e X1-4 (version with contactors), or to the terminals X1-1 and X1-2 (version with motorized changeover switch).

To this end, see paragraph 5.1 or the electrical diagram attached to the panel.

The operating cycle is determined by the genset external control panel. Usually, it happens as follows: when the mains fails, the external panel starts the genset and sends the commands to the ATS BASIC control panel (terminal board X1). Therefore, the switch from MAINS to GENSET is carried out.

Vice versa, once the mains is back and it is followed by the proper delays, the external panel allows the switch from GENSET to MAINS, deactivating the genset afterwards.

The figure below is valid for both versions, that is with contactors and with motorized changeover switch.



The switch from mains to GENSET is signalled by the turning off of the led H1...



...and by the lighting of the led H2.



The switch from genset to MAINS is Signalled by the lighting of the led H1...



...and by the turning off of the led H2.



#### 4.2.5 GENSET Operating mode



With SG selector switch on GENSET (with genset running and ready to supply), you force the switch on GENSET. This operation is signalled by the lighting of the H2 led on the panel.

#### 4.2.6 MAINS Operating mode



With SG selector switch on MAINS (with mains live), you force the switch on MAINS. This operation is signalled by the lighting of the H1 led on the panel.

**In case of mains live**, the SG selector switch allows to carry out the switch from AUTO to MAINS (and vice versa) without creating any voltage drop on the load.

#### 4.2.7 0 Operating mode



With SG selector switch in position 0 (with the motorized switch, at least one of the two sources must be active), you force the switch on position 0 disconnecting the supply of the load. The leds H1 and H2 on the front of the panel are turned off.



## 5 Composition of the Panel

### CARPENTRY (45÷125A)

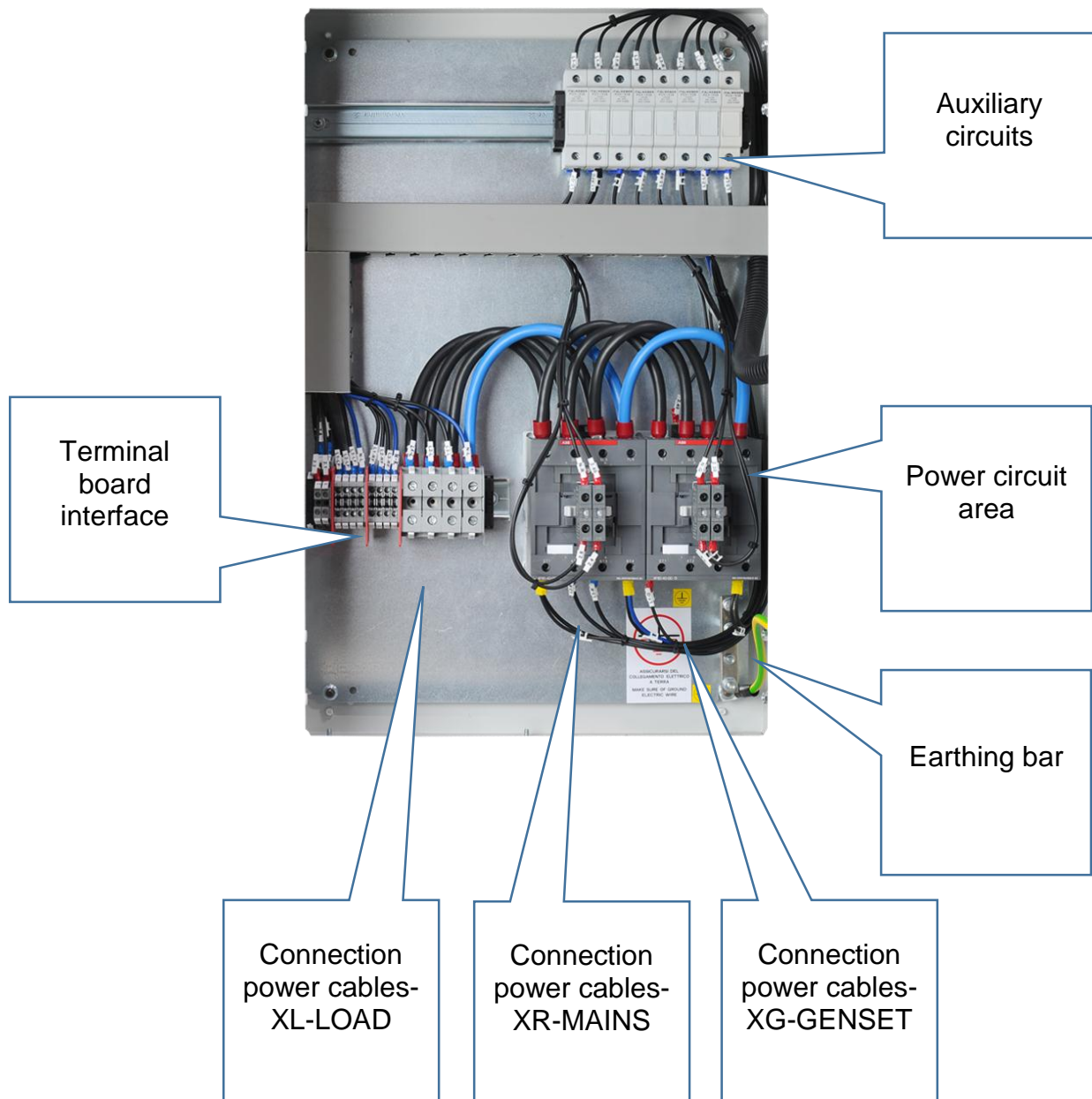

## CARPENTRY (160÷2500A)

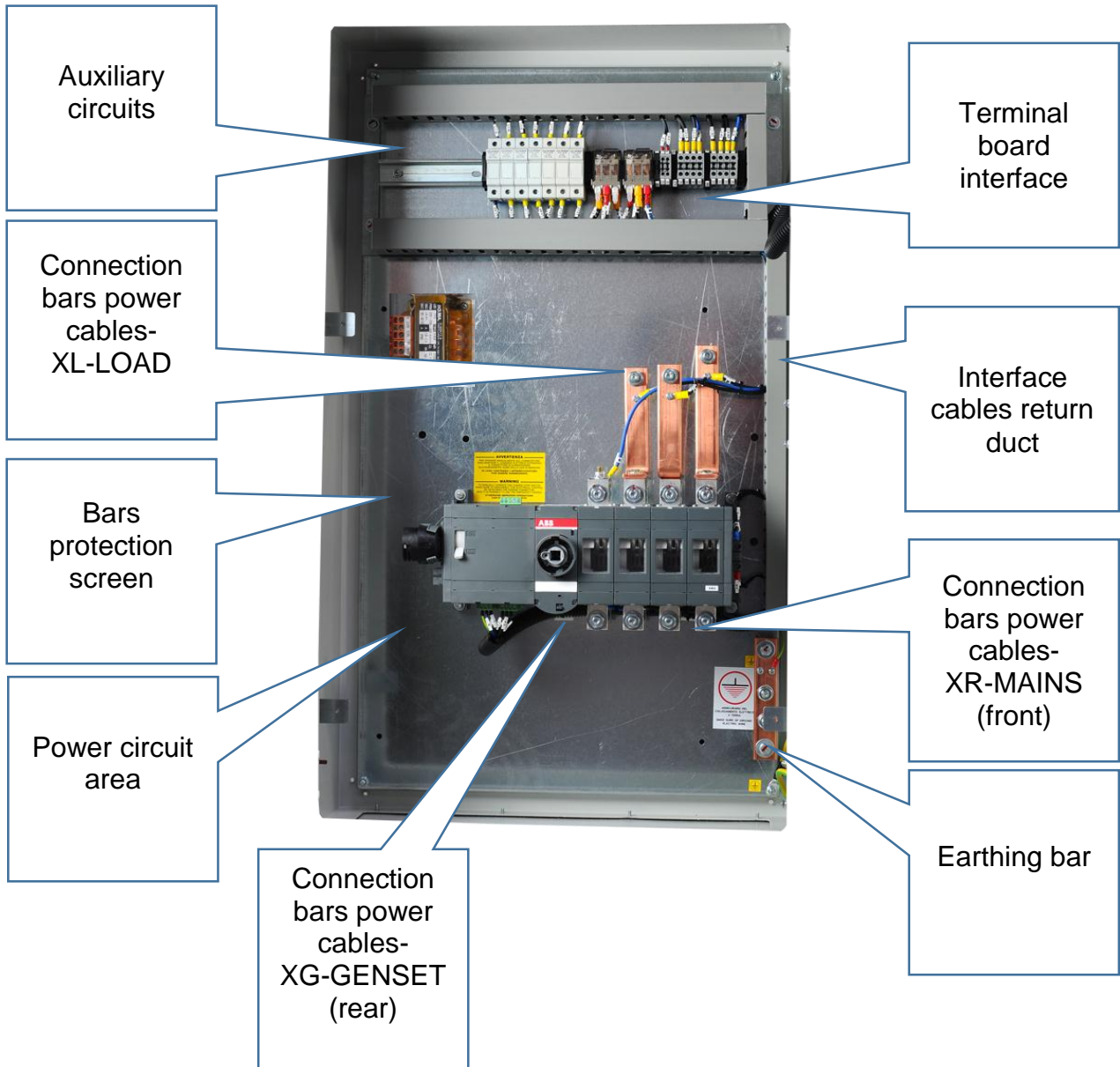

## FLOOR STANDING CARPENTRY (3150÷4000A)

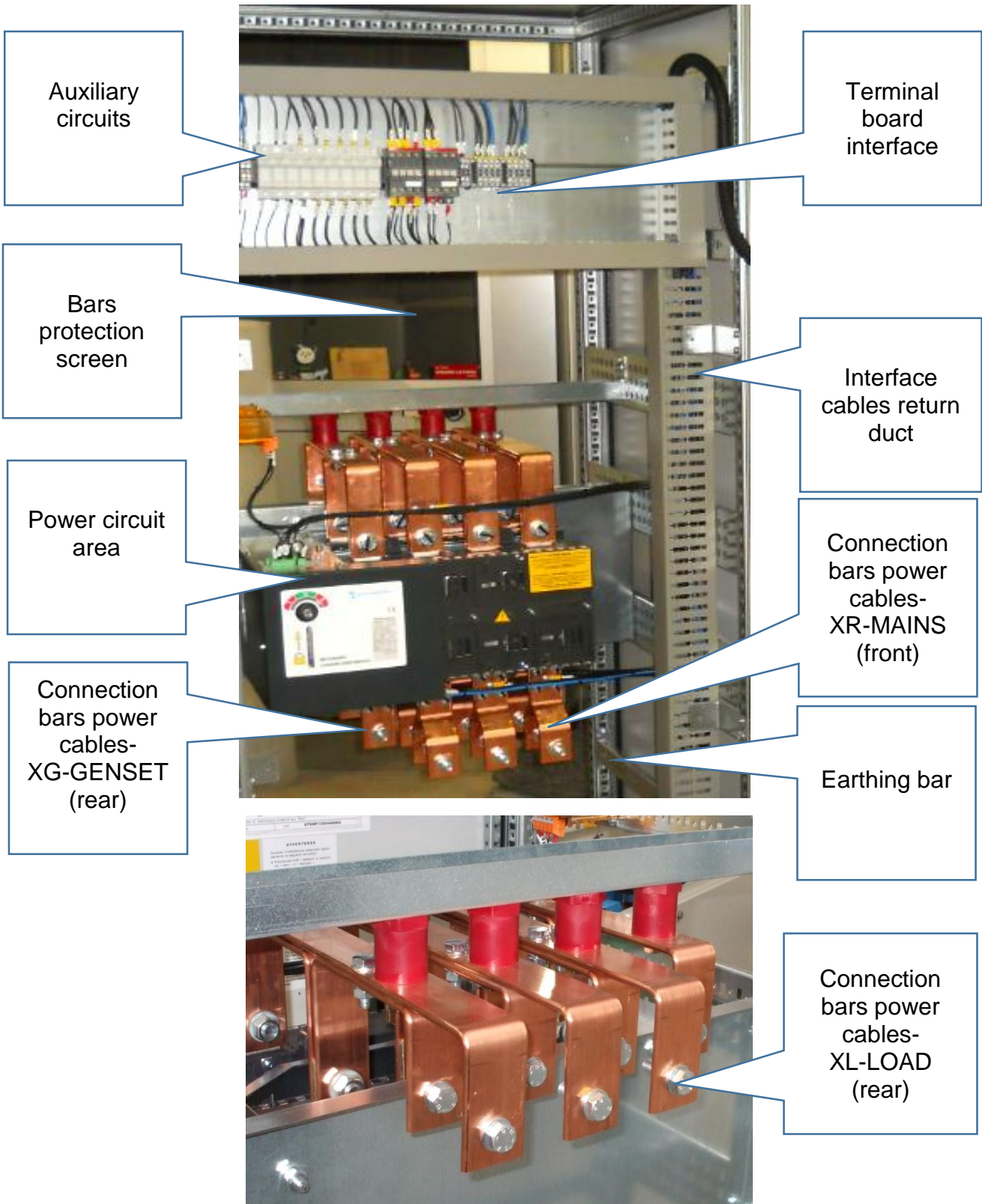

## 5.1 Connection interface terminal board (Switch and Auxiliaries)

Before supplying the control panel, make sure of:

- The respect of the above indications related to the installing, the electrical diagram connection and sections suggested.
- The respect of all the instructions and precautions described in the attachment supplied in the documentation provided with respect to the operating voltage switch.
- Position the SG selector switch on the front of the panel on position "0".

WARNING: in order to avoid the cables whiplash and the switch damage in case of court circuit, it is necessary to fasten the power cables once connected to the switch.

Below there is a principle scheme showing how to interface the panel with the plant. With regard to the power connections, we can consider 2 types: with contactors (45÷125A), with motorized changeover switch (160÷2500A).

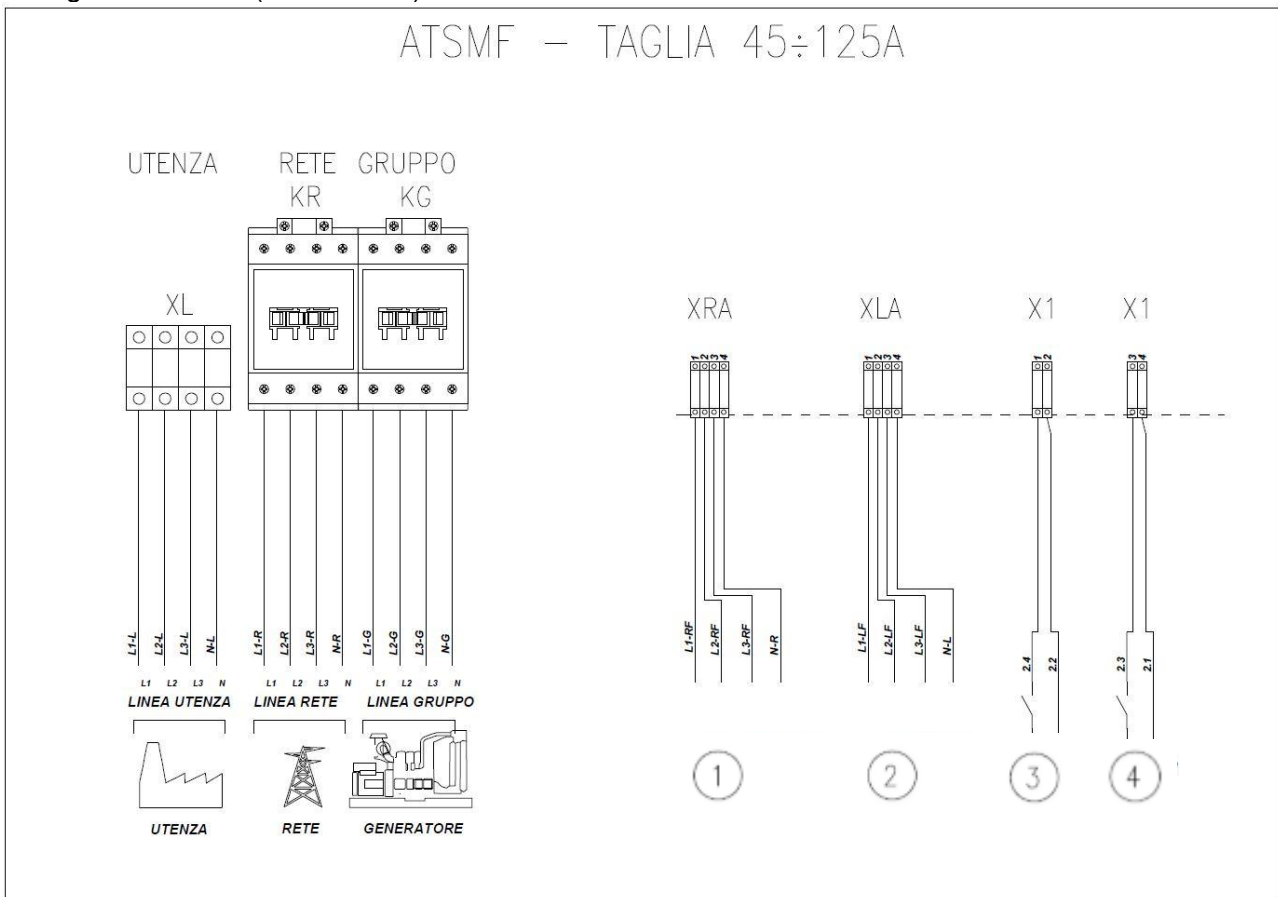

- Couple of ABB contactors -

The arrow indicates the direction of the signal

panel ← → plant

- 1) XRA three-phase supply max 32A by Mains available for possible external panel →
- 2) XLA three-phase supply max 32A by Load available for possible external panel →
- 3) X1 external contact for supply command on genset ←
- 4) X1 external contact for supply command on mains ←

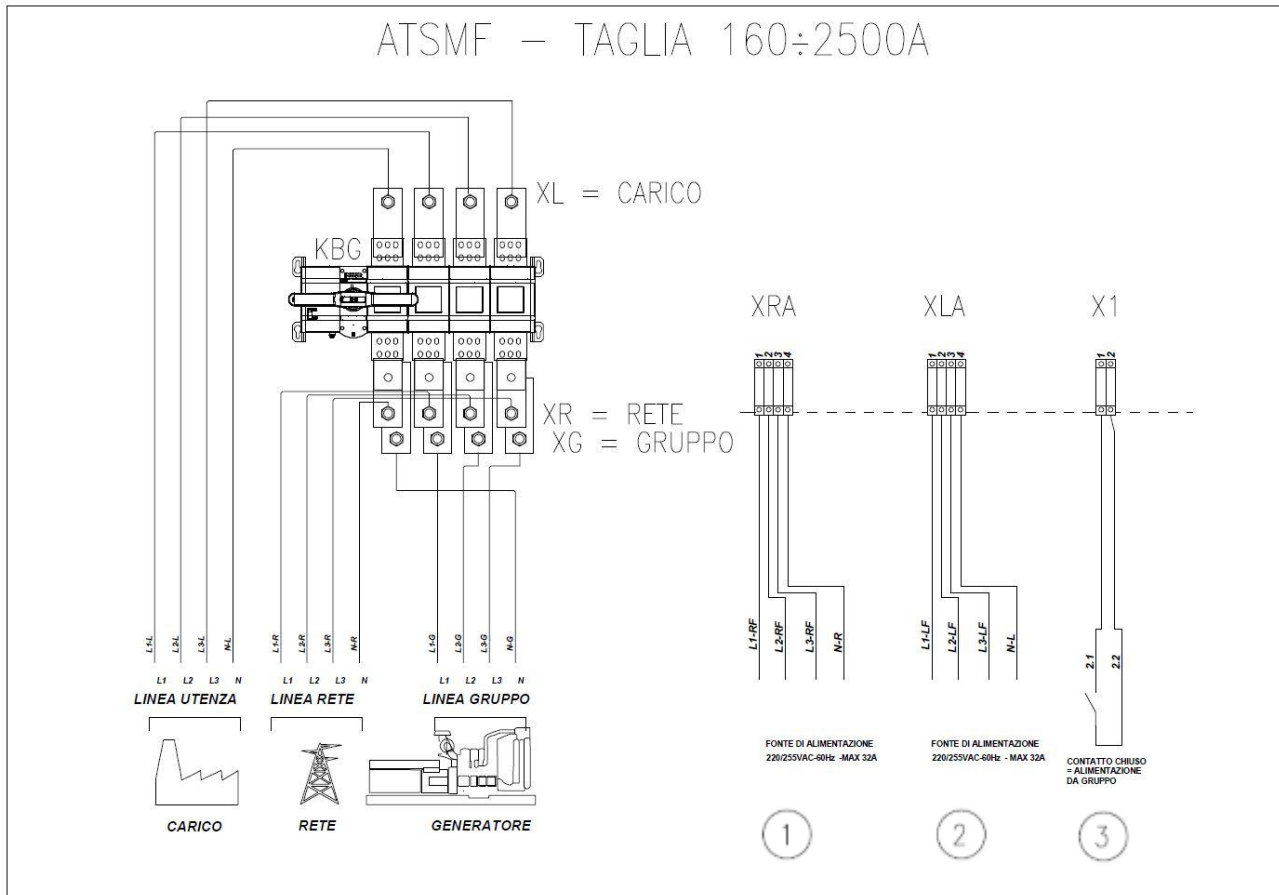

- ABB changeover switch -

The arrow indicates the direction of the signal

panel ← → plant

- 1) XRA three-phase supply max 32A by Mains available for possible external panel→
- 2) XLA three-phase supply max 32A by Load available for possible external panel→
- 3) X1 external contact for supply command on genset←

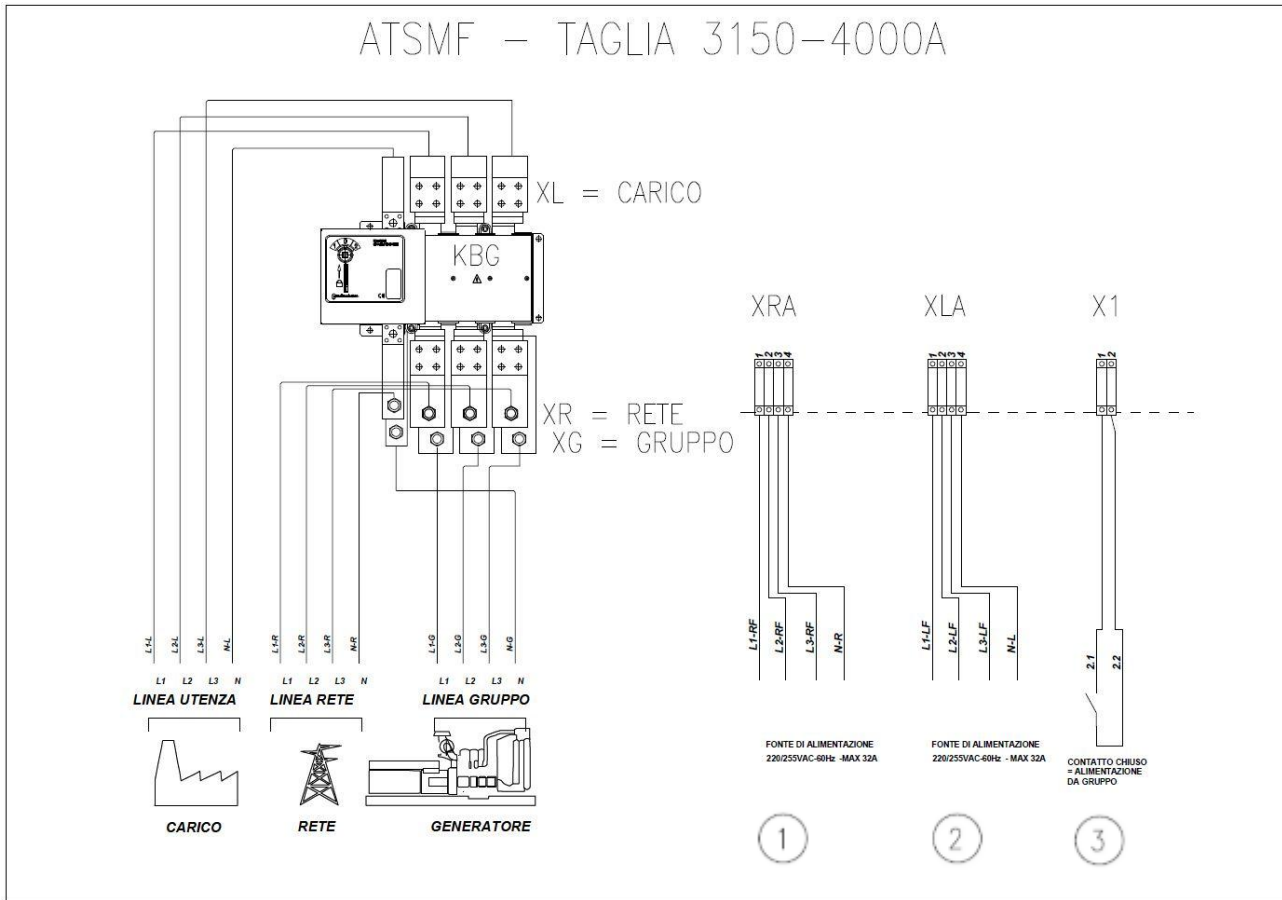



- TECHNOELECTRIC changeover switch -

The arrow indicates the direction of the signal

panel ← → plant

- 1) XRA three-phase supply max 32A by Mains available for possible external panel →
- 2) XLA three-phase supply max 32A by Load available for possible external panel →
- 3) X1 external contact for supply command on genset ←



## 6 Check and maintenance

	<p>Do not carry out maintenance, repair or modification procedures without having specific knowledge or receiving precise indications. All procedures must be carried out in compliance with the safety rules in force.</p>
	<p><b>WARNING</b> <b>THE ELECTRIC CONTROL PANEL IS SUPPLIED BY TWO DIFFERENT SOURCES, MAINS AND GENSET.</b> <b>THE ELECTRIC CONTROL PANEL WORKS EVEN WITH OPEN DOOR.</b></p>

Before carrying out any maintenance procedure, ensure of the absence of voltage by both supply lines, Mains and Genset. In case of panels equipped with protection bars, which must be removed for installation and maintenance, it's absolutely necessary to mount them again once the procedures are over.

Do not remove or force electrical components while the panel is on.

**The opening key of the panel must be given exclusively to authorized personnel.**

WARNING	OBJECT	PRECAUTION
 <p><b>DANGER</b></p>	<p>All the maintenance procedures must be carried out by skilled personnel only. All the control and maintenance activities must be carried out with genset stopped and after disconnecting the panel from all external sources of energy.</p> <p>PAY ATTENTION IN CASE OF EQUIPMENT WITH AUTOMATIC OR REMOTE STARTING SYSTEM: - AUTOSTART; - MISSING MAINS SENSING DISPOSAL; - PROGRAMMABLE FUNCTION FOR AUTOMATIC TEST; THESE ARE ALL FUNCTIONS THAT, IF THE GENSET IS NOT IN BLOCK MODE, CAN PERMIT IT TO GET STARTED EVEN DURING MAINTENANCE OPERATIONS, CAUSING DANGER TO THE TECHNICIAN WORKING ON THE UNIT.</p> <p>Disconnect the devices fed by the Mains, such as the engine preheating system or Mains sensing card. All operations requiring the removal of the protection barriers must be done in the above mentioned conditions ONLY. If the protections are removed, these must be reapplied before the next start-up.</p>	

**Remove voltage supply and turn off the unit in case of malfunction or fault.**

It is prohibited to alter the electrical Panel's parts, position of the components and/or any mechanical and electrical components. Should the above direction be neglected, it may compromise the Panel's safety and it is immediate cause for the null and void of the warranty. Any change made to the panel will be the responsibility of the executor of the change; the executor then becomes the manufacturer.

## 7 Transport, storage and decommissioning

When storing the unit ensure that no other objects are put on top of the panel in order to avoid damages and/or risks of an accidental fall.

The transportation of the electric panel must be carried out so as to safeguard its integrity. Dimensions and weights are indicated on the Panel's identification label and in the documentation attached. (See chapter 10).

All floor standing carpentry over a certain weight is equipped by special rings to be lifted from the high...

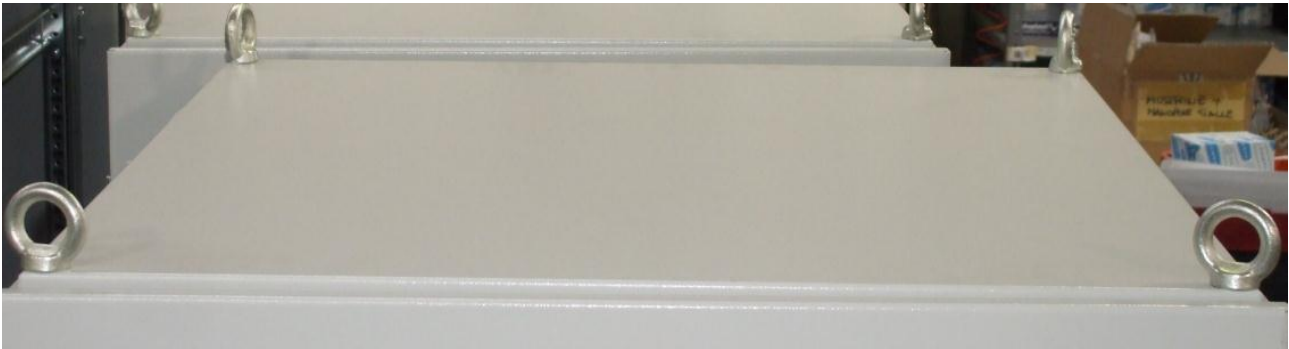

...and special base H:100 for the transportation from the bottom (traspallet).



On receipt of the Panel, check to see if there is any damage caused by transport and check to make sure that the details indicated on the identification label correspond to what was requested.

If the panel is not installed immediately but stored, it is necessary to take some precautionary measures in order to avoid damage to the external case and electrical components inside.

Store the packaged panel in a closed environment that covers and protects against weather conditions and animals. The humidity level must be between 30 and 75% with temperatures between -25°C and +55°C, and a maximum peak of 70°C for very short periods.

At the end of its life cycle or in case of demolition, the equipment has to be decommissioned according to the norms in force in the Country of use. It is also required that the identification labels and any other related document are appropriately destroyed.



## 8 Faults and possible causes

Possible problems connected to the ATS LOGICA Panel are listed in the table below. These can also be conditioned by a fault of the Source A (Mains) or Source B (Genset).

These are general suppositions which are only needed to help explain the problem to the technicians who will then intervene to sort it out. Therefore, the info below has to be considered as general.

EVENT ACKNOWLEDGED	POSSIBLE CAUSES
The selector does not close nor on Mains or on Genset.	<ul style="list-style-type: none"> <li>• Mains not live and Genset stopped.</li> <li>• Protection fuse burned. Replace the fuse.</li> <li>• The remote command of the switch is not allowed. Check the electric continuity of the consent cables and the status of the remote contact.</li> <li>• The contactor coil is faulty (burned, interrupted)</li> </ul>
A Mains or Genset phase/Neutral with contactor closed is missing.	<ul style="list-style-type: none"> <li>• Terminal board not correctly tightened. Tighten the terminals and check that the false contact has not burned the terminals.</li> <li>• The lack of phase/neutral by the mains or the genset causes by the interruption on the distribution wire. Check the distribution wires and the connection points.</li> </ul>

## 9 How to ask for assistance

**To shorten the intervention time of SICES Technical Assistance (SAT) please follow the below shown procedure, providing the required data thus allowing an easy problem solving:**

Try to identify the origin of the fault by consulting the above table;

Contact SICES Technical Assistance SAT having the following information at your fingertips:

- 1) Control Panel data as shown in the plate affixed to the carpentry (\*\*);
- 2) Purchasing document data (Invoice);
- 3) Name of the Company who made the purchase;
- 4) Description of the fault giving as much details as possible about the probable cause, wrong operation or improper use;

(\*\*)

It is very important to refer the Control Panel serial number. If you have already identified the component considered faulty it is useful to refer the written you find in it.

The warranty conditions are indicated in the document **GENERAL CONDITION OF SALE** and it is reminded that the warranty does not apply in the following cases:

- For any damages during the transport.
- For any defects/faults due to improper installation and/or start-up not responding to the safety rules in force.
- For any improper use different from the one given by the instructions provided.
- For any modifications or change performed without authorization.
- For damages due to atmospheric charges or Mains over-voltage of different origin.
- For use of non-original spare parts or with different characteristics from the original equipment.
- For any extraordinary events.

NOTE:

Do not wait until the components are worn out. Replacing a component means improving the efficiency of the control Panel itself and also avoiding more serious damages.

# 10 Our range: overall dimensions



A	H	L	D	Kg
<b>45</b>	600	400	200	21
<b>60</b>	600	400	200	21
<b>90</b>	600	400	200	25
<b>125</b>	600	400	200	25
<b>160</b>	1000	600	250	56
<b>250</b>	1000	600	250	56
<b>400</b>	1000	600	300	60
<b>630</b>	1000	600	400	90
<b>800</b>	1000	600	400	100
<b>1000</b>	1900	800	600	245
<b>1250</b>	1900	800	600	245
<b>1600</b>	1900	800	600	275
<b>2000</b>	1900	800	800	335
<b>2500</b>	1900	1000	800	390
<b>3150</b>	1900	1000	1000	500
<b>4000</b>	1900	1000	1000	750

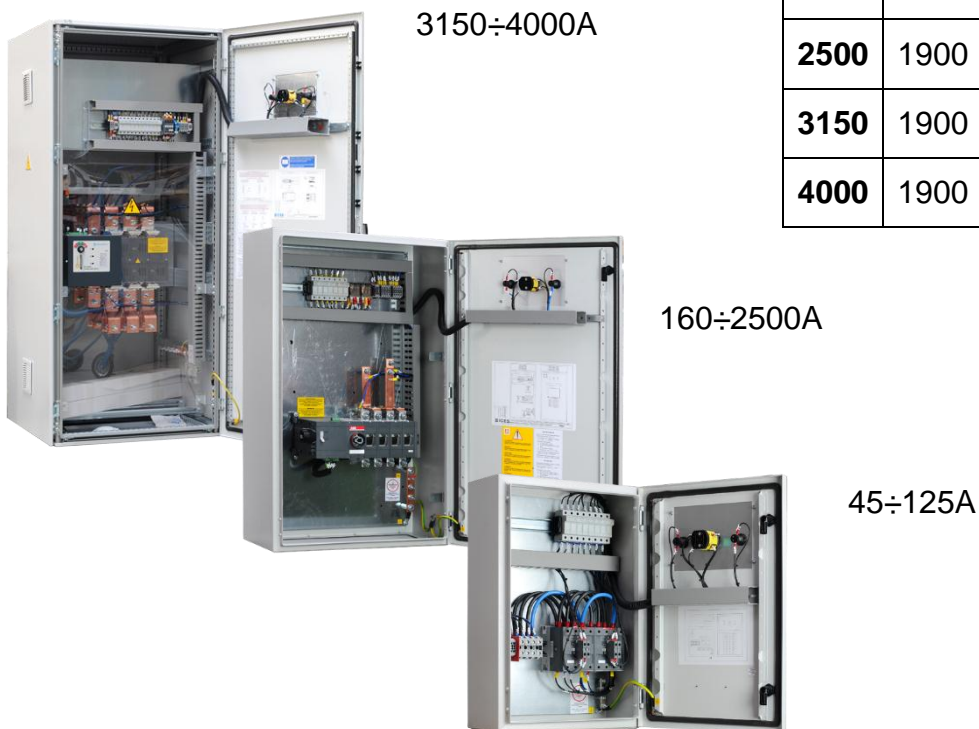

**This document is property of SICES s.r.l.. All rights reserved.  
SICES s.r.l. reserves the right to modify this document without prior notice.**

**SICES has made any efforts to ensure that the information herein provided are correct;  
by the way SICES does not take charge for the incorrect use of these information.**

**The disclosure of this document by any means to third parties is not allowed.**

**S.I.C.E.S. SRL**  
**Società Italiana Costruzioni Elettriche Sumirago**

Via Molinello 8B  
21040 - Jerago con Orago (VA) ITALY

T +39 0331 212941  
F +39 0331 216102

[www.sices.eu](http://www.sices.eu)  
[sales@sices.eu](mailto:sales@sices.eu)

**SICES BRASIL LTDA**

Avenida Portugal, 1174  
Condominio Empresarial ONIX  
06696-060 / ITAPEVI (SP)

T +55 11 4193 2008

[www.sicesbrasil.com.br](http://www.sicesbrasil.com.br)  
[contato@sicesbrasil.com.br](mailto:contato@sicesbrasil.com.br)

